

# O'2NAILS

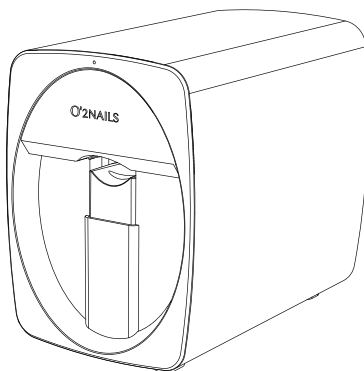

## Mobile Nail Printer | M1

User Manual

Please read this User Manual carefully  
before using this printer and keep it properly for future reference.

# Catalog

- 02 Product Introduction
- 03 APP Download
- 04 Pattern Download
  - 1.Downloading way of standard patterns
  - 2.Downloading way of new nail styles
  - 3.How to get the nail style tutorial
- 05 Connect Power
- 06 Connect the Nail Printer on the APP
- 07 Cartridge Installation
- 09 Ink Cartridge Setting and Single Nail Calibration
  - 1.Ink cartridge test
  - 2.Color setting
  - 3.Ink cartridge options
  - 4.Single nail calibration
- 10 Ink Cartridge Maintenance
- 11 APP Introduction
- 12 DIY Gallery
- 13 Instruction of Nail Pattern Printing
- 14 Warranty Policy

# Product Introduction

## Mobile Nail Printer M1

A Nail Art Equipment that Prints Any Pattern, Any Color and Any Design on the Natural Nail and Artificial Nail.

### Features

- Controlled by Phone APP
- Massive Designs Available for Download
- Design Personal Patterns by Yourself
- Classifications for Quick Search
- Classify Common-Used Patterns Optionally

Trademark: O2NAILS

Product Name: Mobile Nail Printer M1

Model: FM-NP1801V

Power Input : 5V/2A

Power Rating: 10W

Machine Dimension: 160x100x139 ( mm )

Net Weight: 0.5KG

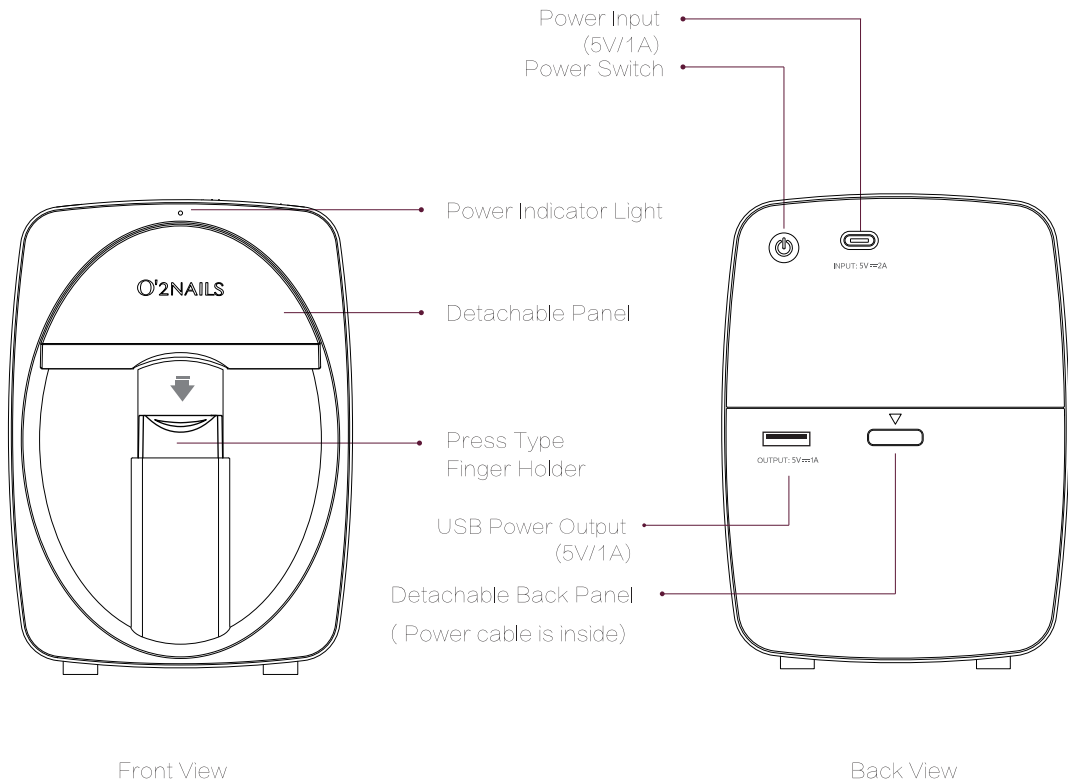

# APP Download

Method one:



O2Nails



Scan QR code to download

Method two:



App Store



Search "O2NAILS"



Download



Application Market



Search "O2NAILS"



Download

Method three:

Download from official website [WWW.O2NAILS.COM](http://WWW.O2NAILS.COM).

## Register and Login

Please ensure to login before printing, the icon will become "Personal Center" after login.

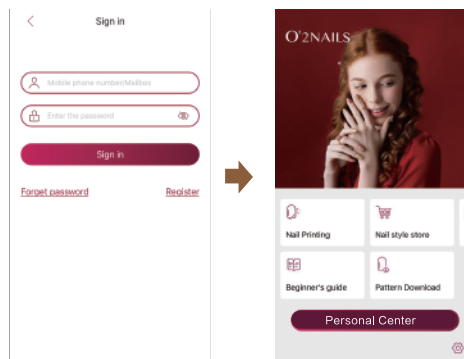

# Pattern Download

## Downloading way of standard patterns

Click “Pattern Download” at home page, and then click “Click to download all patterns” .

When this downloading finishes, click the button on top right corner to download all eight incremental packages.

You have downloaded all standard patterns when the above downloading finishes, then you can back to home page, click “Nail Printing” and “All galleries” to browse those patterns.

Nail style store updates new styles continually

## Downloading way of new nail styles

Click “Nail style store” at home page, select the style you like and click into the “ design introduction” page, and then click “Download now” to download this style.

You can continue to download other styles you like.

At home page, click “Nail Printing” and “All galleries” , you can browse the style patterns here, and each style has tutorial in detail.

## How to get the nail style tutorial

Click “Personal Center” at home page, then click “Download” and the icon “ √ ” on right, you will see “Tutorial” ,

click it to check the corresponding tutorial.

# Connect Power

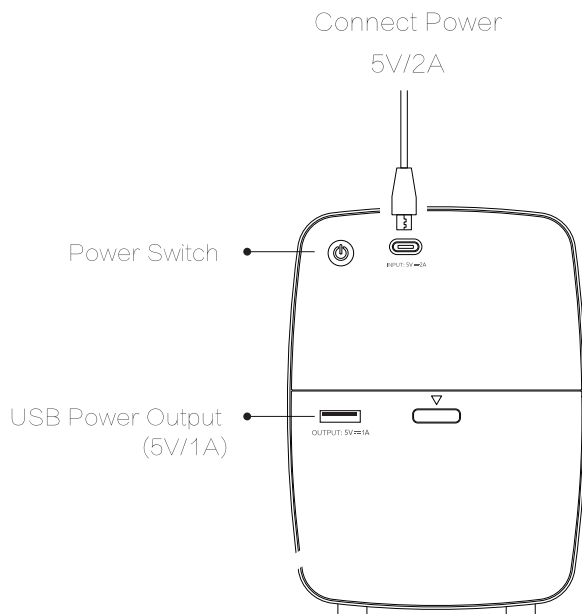

## Power Switch

Click the power switch to turn on the printer and the indicator light will be on.

Long press the power switch for 3 seconds to turn off it.



## Attentions

Avoiding insufficient power supply, please do not use the Nail Printer and the LED Gel Light at the same time.

If the printer needs to be transported for a long distance, please use original package to pack it, avoiding any damage by shaking.

Do not use it in high temperature, humid, or corrosive places.

# Connect the Nail Printer on the APP

## 1.Power Switch



Click the power switch to turn on the printer and the indicator light will be on.

## 2.Connect to the machine

Connect mobile phone to WIFI hotspot of Nail Printer

Hotspot name: O2nails-XXXXXXXX

Initial password: 88888888

# Cartridge Installation

## 1. Open O2nails application

Click setting on lower right corner “”

Take down the panel ,

Then click “**Ink Cartridge Test**” , and then click “” ,

Click “**Cartridge ejection**” , and start to install ink cartridge.

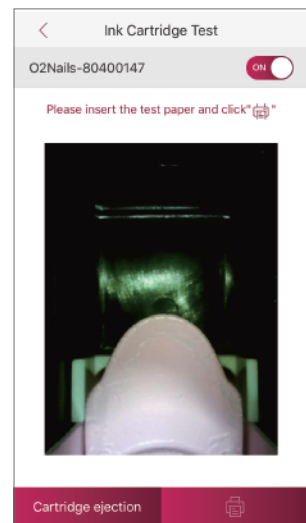
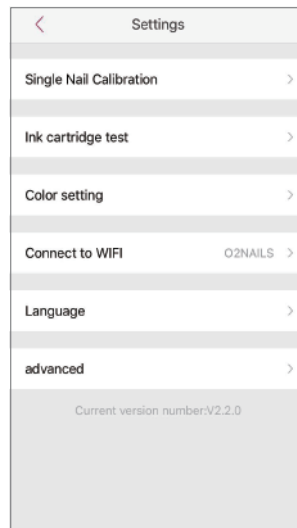
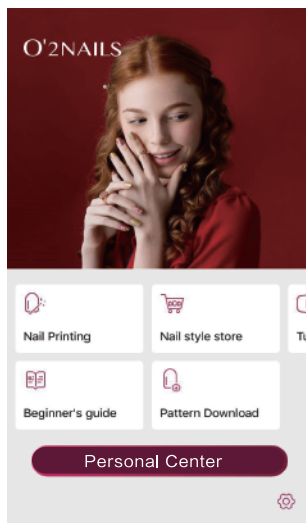



### 3. Unpack the Ink Cartridge

Unpack the ink cartridge and remove the protective seal.

Please place it correctly and do not touch the nozzle.

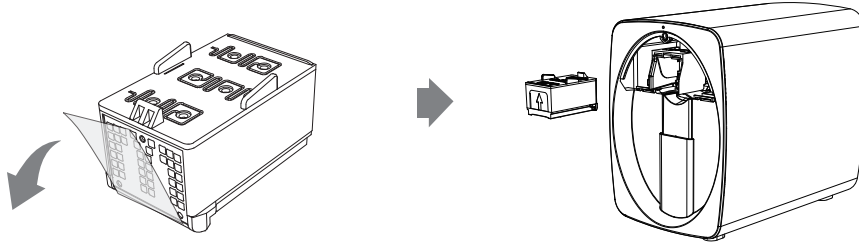

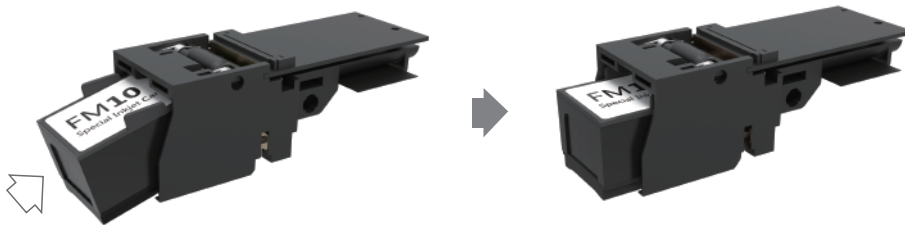

### 4. Install Ink Cartridge

Find the cartridge holder and move the cartridge close to the cartridge holder, making the cartridge top surface touches the holder reference surface, then levelly push it into the holder and you' ll hear the click sound. Please ensure it is installed tightly.



# Ink Cartridge Setting and Single Nail Calibration

## 1. Ink cartridge test

Open the Wi-Fi button  after the cartridge installation, then click  and wait for the test completes.



## 2. Color setting

Back to “Settings” page,  
Click “Color setting” , the default setting is “Dark” , you can change it by your need,  
and click “Save” to finish the setting.

## 3. Ink cartridge options

Back to “Settings” page, click “advanced” and “Ink cartridge options” , then connect the machine Wi-Fi and open the Wi-Fi button   
Select the ink cartridge model according to its label and click “Save” to finish the setting.  
If the ink cartridge model doesn’ t change, you don’ t need to set the options even replace a new ink cartridge.

## 4. Single nail calibration

If there’ s printing position deviation, which can be solved through Single Nail Calibration.  
Click the Settings button  at home page, select “Single Nail Calibration” , then connect the machine Wi-Fi and open the Wi-Fi button  .  
Put half a folded A4 paper into the machine and make it fill the whole screen, and then click the “Print” button on left bottom.  
After the printing finishes, if the dotted rectangle doesn’ t overlap with the printed one on paper, please adjust the dotted one overlap with the printed one and then click the “Save” button.

# Ink Cartridge Maintenance

If the machine cannot recognize the ink cartridge after installation, here below maybe the causes and solutions:

The first cause, the ink cartridge wasn't totally installed into its holder.

Please reinstall it and make it parallel to the front side of the cartridge holder.

The second cause, the contactor on the cartridge or its holder has dust.

Please take out the cartridge, and then use dry tissue to clean the contactor.

**The below considerations are for the ink cartridge:**

1. Please remember to remove the seal when open the cartridge package.
2. To avoid ink becoming dry, please install the cartridge into the machine after opening package.
3. To avoid ink color mixing, please do not put the cartridge sideways or upside down.
4. To avoid ink becoming dry and clogging the nozzle, please do not put the machine in front of the air outlet.
5. Please do not transport the ink cartridge after opening package .
6. In order to get good printing quality, please set the cartridge options and calibrate the printing position before pattern print.

# APP Introduction

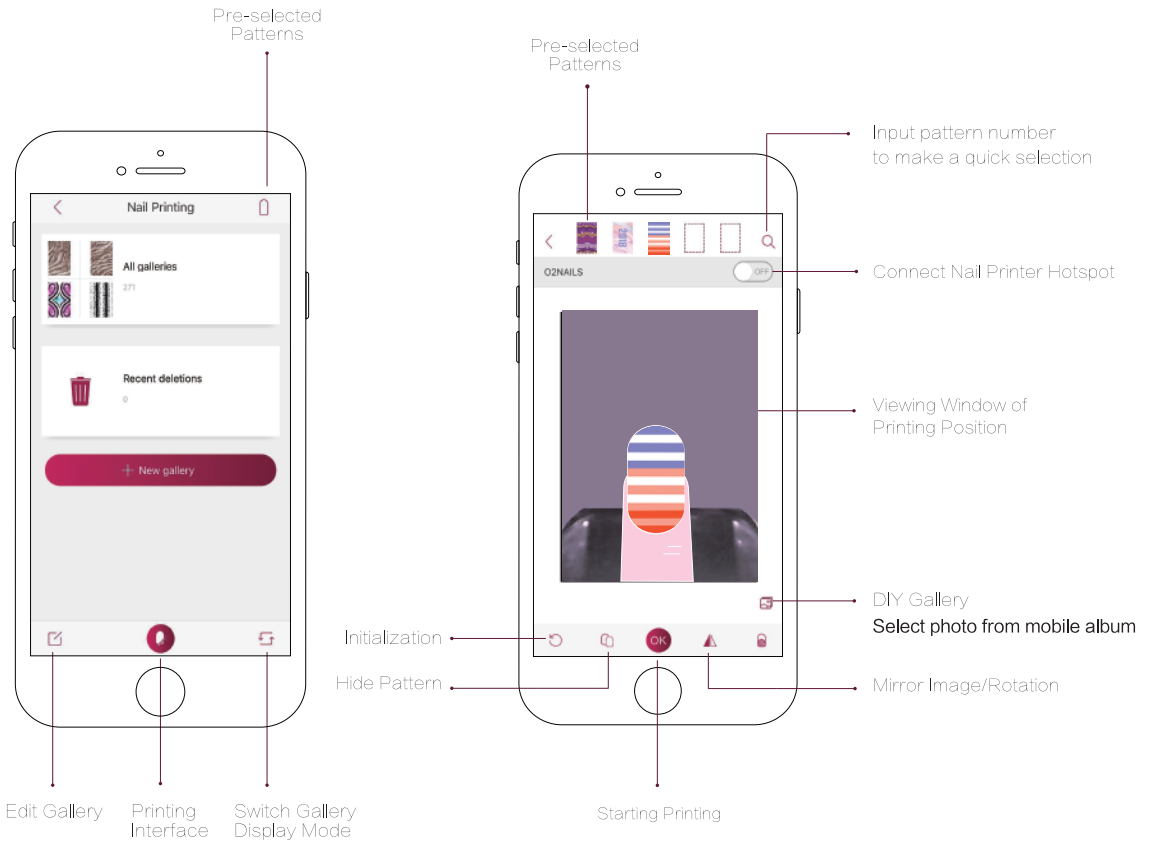

# DIY Gallery

Click DIY Gallery icon to open the mobile album, select the photo you want, and then adjust its size, color settings and direction, click “√” on top right corner to save it.

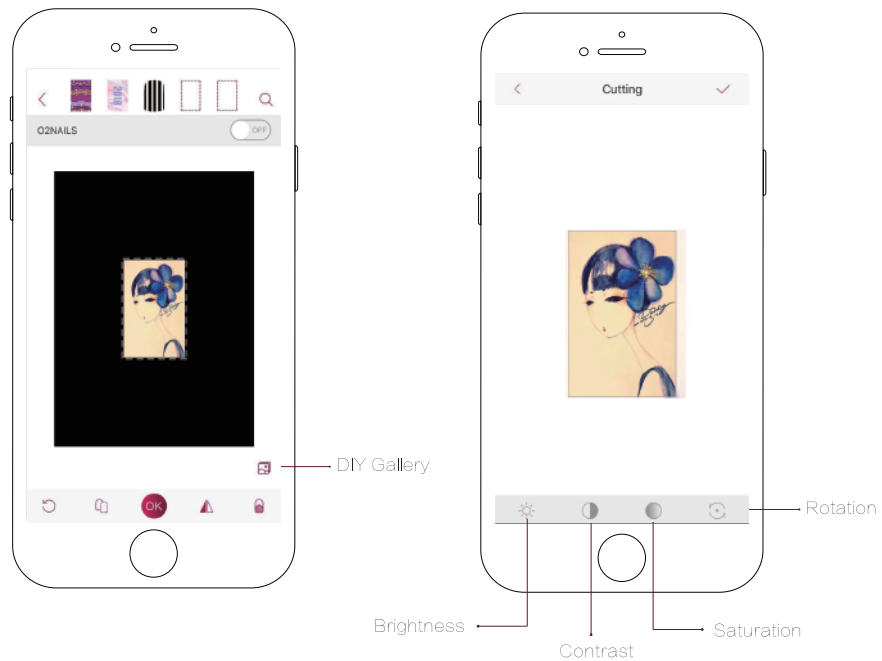

# Instruction of Nail Pattern Printing

Please refer to detailed printing tutorial on O2nails APP. (The APP download method is at page 04)



# Warranty Policy

Within the warranty period specified in the product warranty card and according to the warranty policy, if the product has any problem under the normal and operating instruction use, the user can apply warranty service from O2nails or its authorized dealer. Please present the warranty card and purchase invoice when you apply this service.

## **1. Warranty period and warranty coverage**

- 1) The duration covered by this warranty is one year from the date of purchase.
- 2) If the product has any problem under normal and operating instruction use, according to the warranty policy, the user can apply warranty service from O2nails or its authorized dealer. Please present the warranty card and purchase invoice when you apply this service.
- 3) The product repaired by O2nails or its authorized dealers will continue to enjoy the warranty service during the original warranty period. If it's less than 90 days from the end of the warranty, the replacement parts will enjoy 90 days warranty from the date of its replacement.

## **2. Repair for the following conditions will be charged accordingly**

One of the following conditions, even if the product is under warranty, cannot be treated as under warranty product, but can be repaired at a charge:

- 1) One year after the date of purchase.
- 2) Cannot present the valid warranty card or the purchase invoice (except can prove that the product is under warranty).
- 3) Damages caused by failure to use, to repair, or to keep the product in accordance with the instructions (including but not limited to external voltage, current, electromagnetic, abnormal changes in public circuits, etc., those caused by using this product outside the specified environment).
- 4) Damages caused by cleaning, repair, disassembly, mishandling, or other maintenance which isn't operated by O2nails or its authorized dealers.
- 5) Damages caused by the use of non-original ink cartridges and non-original spare parts.
- 6) Damages caused by improper movement or improper transportation of the product by the user

- 7) Appearance damages such as abrasion or stains caused during use.
- 8) Damages caused by external causes such as irresistible natural disasters or abnormal voltages.
- 9) The purchase date, product model, buyer name, and dealer name are not recorded or altered on the warranty card.
- 10) The product model listed on the warranty card does not match the actual product.

### **3. Starter Kit quality assurance policy**

For O2nails original starter kit, including the LED gel light, ink cartridge, and gel polish, if there' s any quality problem of themself and is confirmed by designated professional technician within seven days after receipt, O2nails provides replacement service.

The following conditions are not included:

- 1) Quality problems caused by damaged transportation or improper use by users.
- 2) After the ink cartridge is unsealed, the ink cartridge is color mixed by returning the seal to the nozzle.
- 3) The ink cartridge is clogged due to improper operation, which affects the print quality.

Notice: As not to miss the seven-day replacement period, please check the quality of the starter kit as soon as possible after receiving the O2nails nail printer.

### **4.The spare parts replaced in the warranty are owned by O2nails.**

### **5.How to get the warranty service?**

- 1) If you need to use the warranty service, please inform O2nails or its authorized dealer about the damages situation, and present the warranty card and purchase invoice.
- 2) The professional technician designated by O2nails will identify whether the product is a malfunction or damages caused by non-human factors. If it is caused by non-human factors, O2nails will repair the product properly and bear the cost of repair and the cost of its return, but the user should be responsible for the cost of shipping the product to O2nails. If the damaged product is not covered by the warranty, but the user requests to use the warranty service, the user should be responsible for the all the shipping costs and repair costs.
- 3) If you need to apply the warranty service, please contact O2nails authorized dealers that you purchased from, or contact O2nails.

### **O2nails service contacts:**

Tel: +86-400-098191      Email: [service@cybermail.com](mailto:service@cybermail.com)      Wechat: ArtproNail



# Warranty Card

**O'2NAILS**

Dear Customer,

Thanks for your focus and support of our products as well as your selection and purchase of our products. In case of any problem during the use of our products, please contact our distributor or manufacturer for help.

## ● Product information

Product model: \_\_\_\_\_

Serial number: \_\_\_\_\_

Purchase date: \_\_\_\_\_

Purchase region: \_\_\_\_\_

Dealer: \_\_\_\_\_

Remark:

## ● Buyer information

Name: \_\_\_\_\_

Tel: \_\_\_\_\_

Email: \_\_\_\_\_

Address: \_\_\_\_\_

In order to provide you better after sale service, please log in [WWW.O2NAILS.COM](http://WWW.O2NAILS.COM) to learn more.

# FCC

Caution: The user is cautioned that changes or modifications not expressly approved by the party responsible for compliance could void the user's authority to operate the equipment.

This device complies with Part 15 of the FCC Rules. Operation is subject to the following two conditions: (1) this device may not cause harmful interference, and (2) this device must accept any interference received, including interference that may cause undesired operation.

NOTE: This equipment has been tested and found to comply with the limits for a Class B digital device, pursuant to Part 15 of the FCC Rules. These limits are designed to provide reasonable protection against harmful interference in a residential installation. This equipment generates, uses and can radiate radio frequency energy and, if not installed and used in accordance with the instructions, may cause harmful interference to radio communications. However, there is no guarantee that interference will not occur in a particular installation.

If this equipment does cause harmful interference to radio or television reception, which can be determined by turning the equipment off and on, the user is encouraged to try to correct the interference by one or more of the following measures:

- Reorient or relocate the receiving antenna.
- Increase the separation between the equipment and receiver.
- Connect the equipment into an outlet on a circuit different from that to which the receiver is connected.
- Consult the dealer or an experienced radio/TV technician for help.

FCC Radiation Exposure Statement:

This equipment complies with FCC radiation exposure limits set forth for an uncontrolled environment.

This transmitter must not be co-located or operating in conjunction with any other antenna or transmitter.

This equipment should be installed and operated with a minimum distance of 5cm between the radiator (which is on the bottom of the product) and your body.



- a. For PLUGGABLE EQUIPMENT, the socket-outlet shall be installed near the equipment and shall be easily accessible.
- b. Only use the attachments/accessories specified by manufacturer.

# O'2NAILS

GUANGZHOU TAIJI ELECTRONIC CO., LTD. (Manufacturer)  
E1, 25/F, Everbright Bank Building, No. 689 Tianhe North Road, Guangzhou, China  
Hotline : (+8620) -38732006 / +86-400-098191  
E-Mail:SALES@CYBERNAIL.COM  
WWW.O2NAILS.COM

All information and data listed on this manual are for reference only,  
the final explanation right belongs to this company.

2018-09